

# CORAB T-021 T-024



## INSTRUKCJA MONTAŻU

## INSTALLATION MANUAL

Dach skośny  
blacha trapezowa  
moduły pionowo/poziomo  
dla 4 modułów

Sloped roof  
trapezoidal sheet  
portrait/landscape modules layout  
for 4 modules

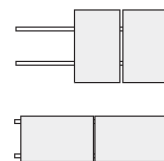

Narzędzia potrzebne do montażu/Tools needed for installation

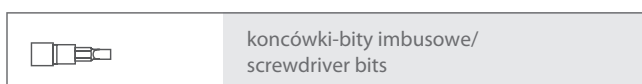
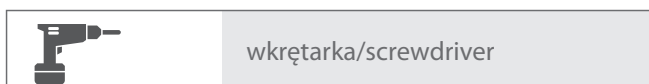
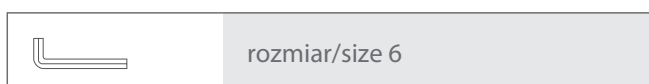

### Elementy/elements

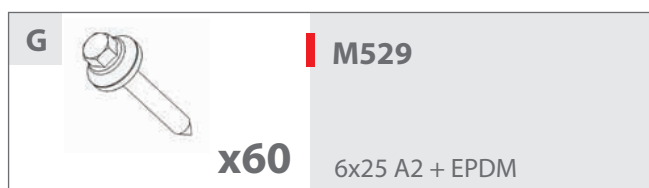
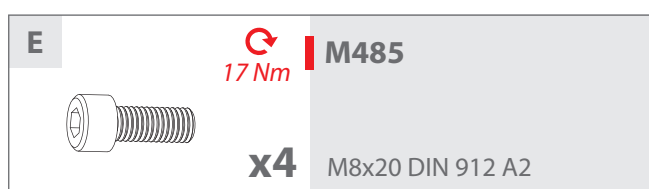
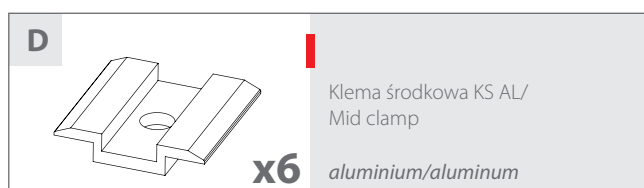
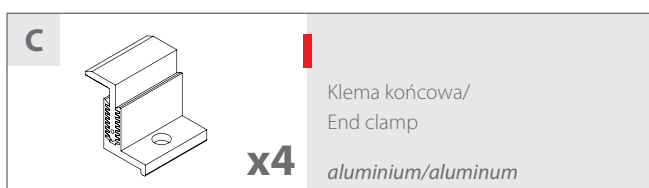
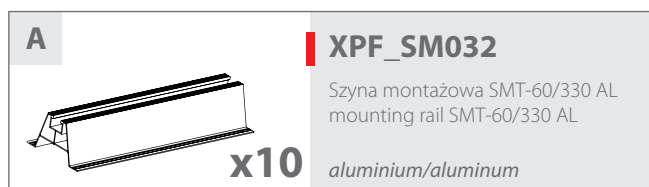

Maksymalna odległość między punktami podparć = 1200 mm.  
Maksymalna odległość końca szyny od ostatniego podparcia = 300 mm  
Max distance between points of support = 1200 mm  
Max distance between end of rail and last point of support = 300 mm

1

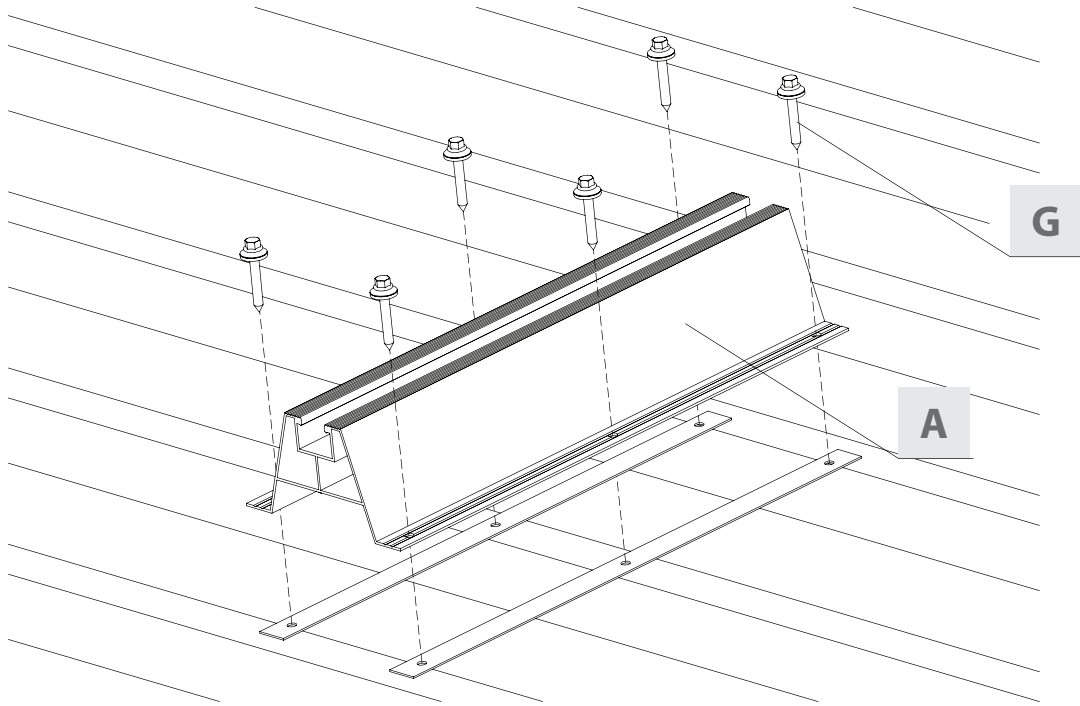

2

